



P 101
8 / 6



P 102
10 / 6



P 105e
15 / 8



P 106
23 / 14

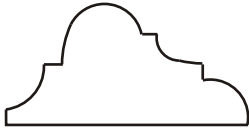

P 107
32 / 16

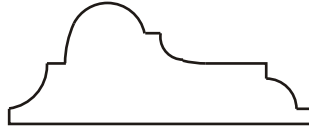

P 108
40 / 16

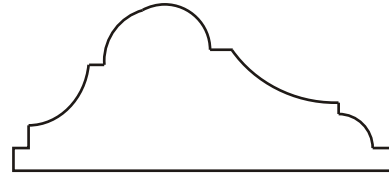

P 109
50 / 22

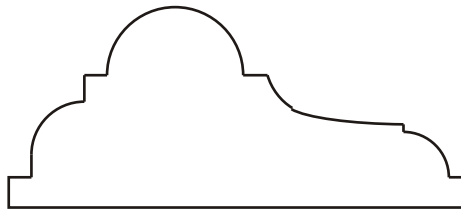

P 110
60 / 27

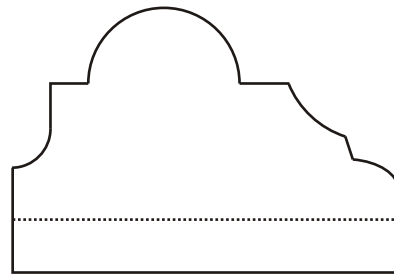

P 111
51 / 35
51 / 28



P 113
23 / 10



P 114
29 / 11

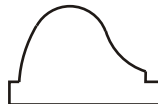

P 115
20 / 13



P 116
35 / 12

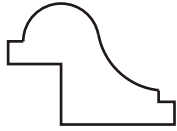

P 206
22 / 16

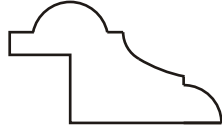

P 207
28 / 16

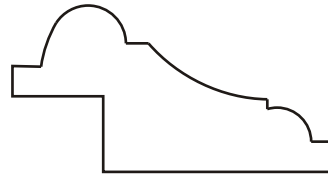

P 209
42 / 22

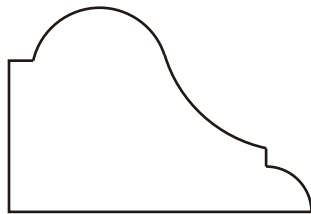

P 120
40 / 27

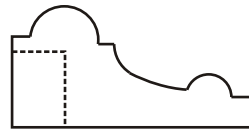

P 118
32 / 16

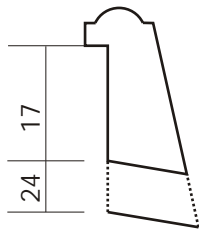

P 404
15 / 22/29

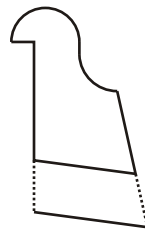

P 403
18 / 22/29



P 401
12 / 22/29



P 402
12 / 22/29

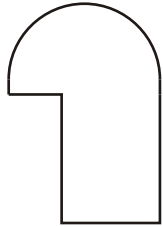

P 215
20 / 29

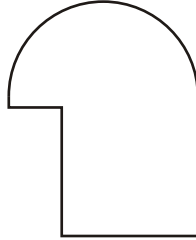

P
25 / 31

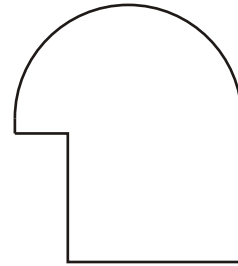

P 216
30 / 34



P 121
20/12

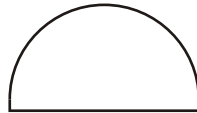

P 122
30 / 17

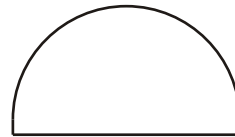

P 122
30 / 17

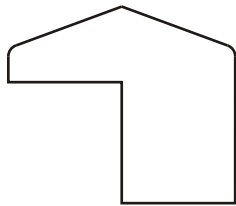

P 215
20 / 29

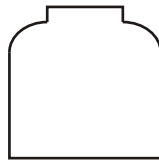

P
20 / 20

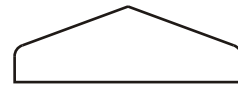

P
30 / 10



P
18 / 36

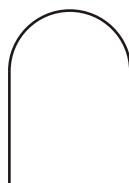

P
16 / 22



P
30 / 16

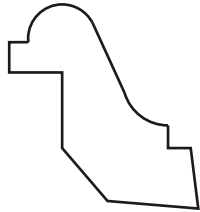

P 301
25 / 27

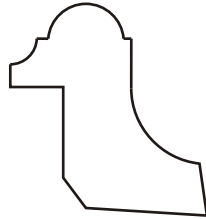

P 305
26 / 28

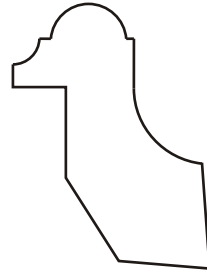

P 306
26 / 35

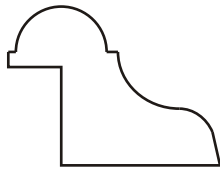

P 212
28 / 21

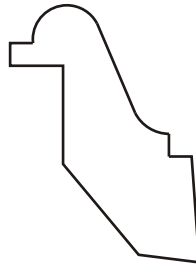

P 302
25 / 34

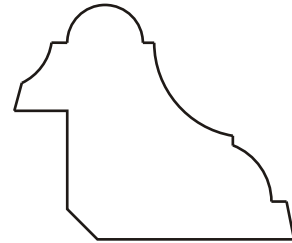

P 213
28 / 21

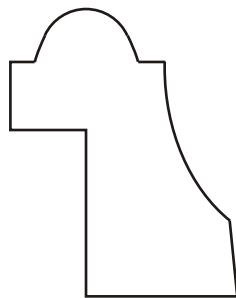

P 214
30 / 38

Bilderrahmenleisten

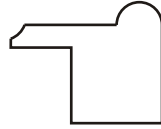

P 801
20 / 16

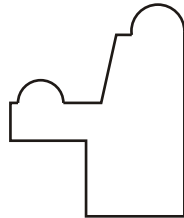

P 802
23 / 28

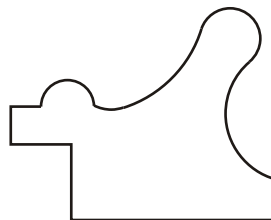

P 804
35 / 28

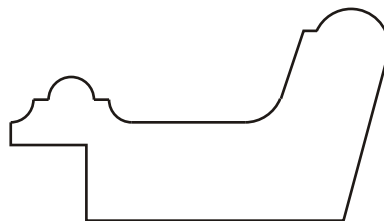

P 803
50 / 28

Segmentbogen

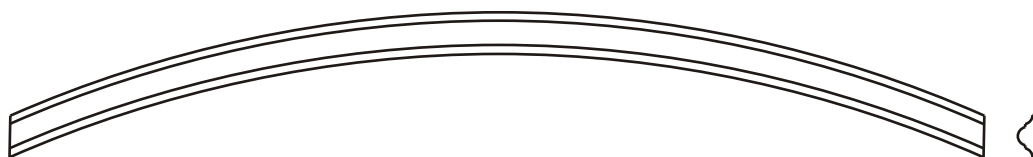

Länge 720mm Stichhöhe 50mm
Radius 1250mm
passend zu vielen Profilen - siehe Preisliste

Karnies

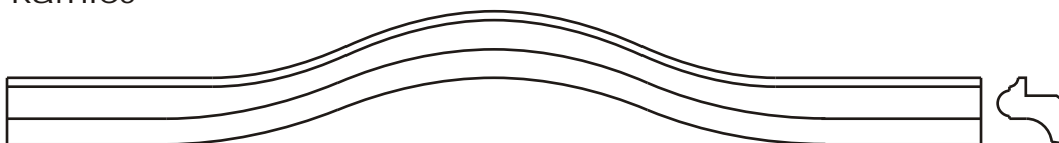

Länge 720mm Stichhöhe 50mm
Radius 1250mm
passend zu vielen Profilen - siehe Preisliste

Viertelecken

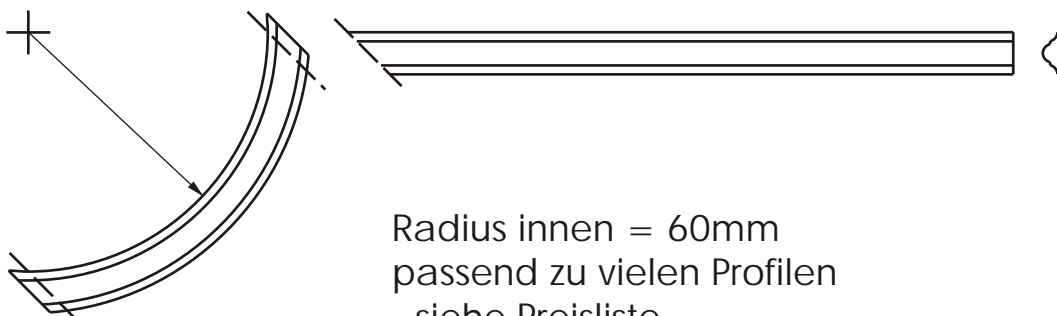

Radius innen = 60mm
passend zu vielen Profilen
- siehe Preisliste

Schichtverleimte Profilrundbogen

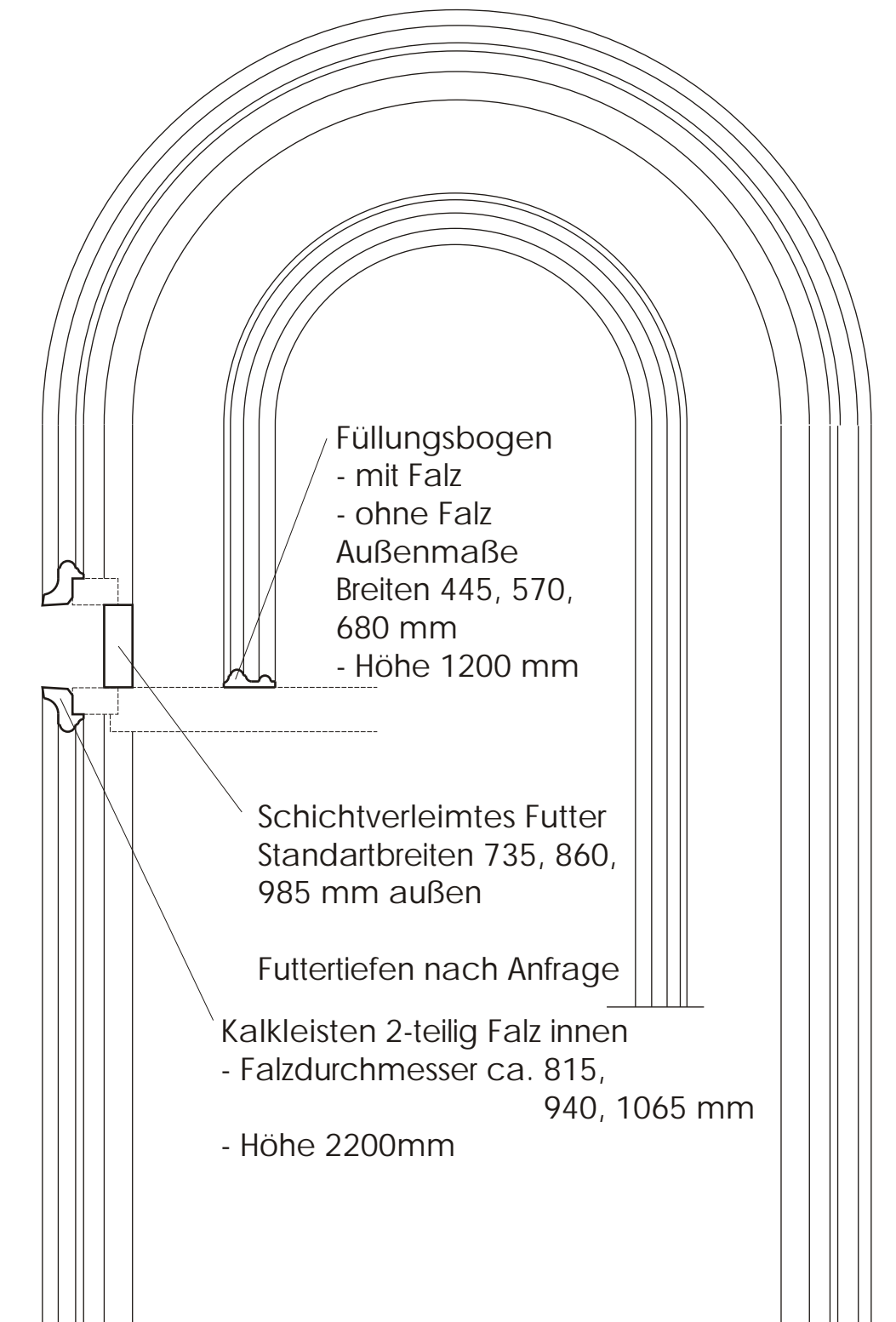

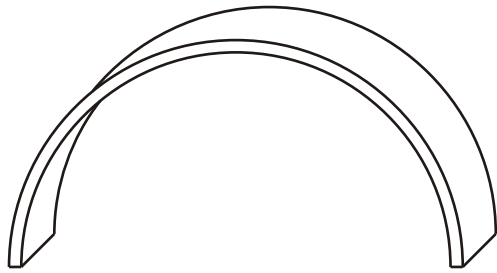

Schichtverleimte Zargen

Formen

- halbrund
- kreisrund
- oval
- mit gerundeten Ecken
- Rinnenförmig usw.

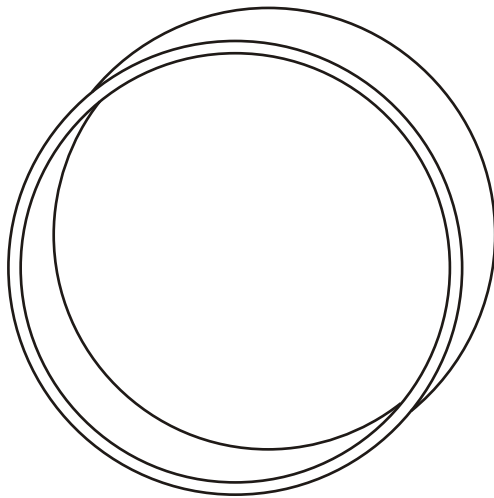

Aufbau

- Furnierschichten längs
- Furnierschichten kreuzweise
- Spanplatten usw.

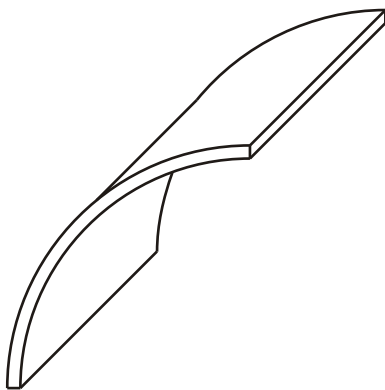

Verwendung

- Korpusteile für Möbel
- Futterteile für Türen
- Dekorationselemente
- Tischzargen usw.

Preise

- werden nach Ihren Angaben (Durchmesser, Breite, Stärke, Aufbau und Stückzahl) abgegeben

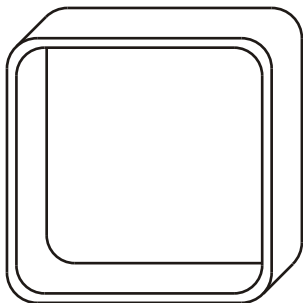

Sprossenrahmen für Zimmertüren

| Höhe mm | Breite mm | Sprossen |
|------------|--------------|--------------|
| 1440 | 680 | 1 Senkrechte |
| | 555 | 2 Quere |
| | 430 | |
| | 680 | 1 Senkrechte |
| 1440 | 555 | 2 Quere |
| | 430 | mit Bogen |
| 1440 | 680 | 2 Senkrechte |
| | 555 | 3 Quere |
| | 430 | |
| | 680 | 2 Senkrechte |
| 1440 | 555 | 3 Quere |
| | 430 | mit Bogen |
| 956 | 680 | 2 Senkrechte |
| | 555 | 2 Quere |
| | 430 | |
| | 680 | 2 Senkrechte |
| 956 | 555 | 2 Quere |
| | 430 | mit Bogen |



P 215
20 / 29

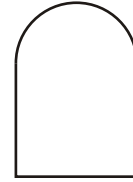

P
16 / 22



P
17 / 28

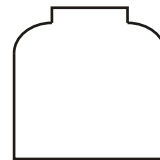

P
20 / 20

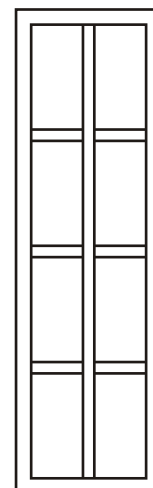
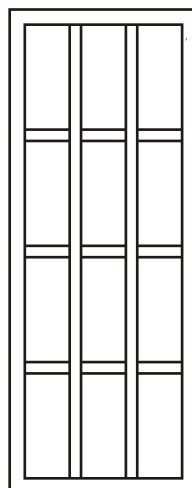
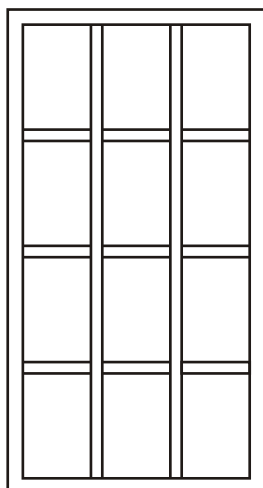
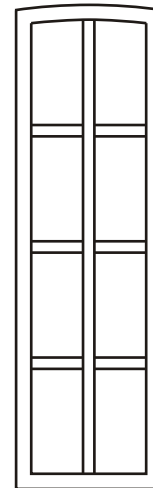
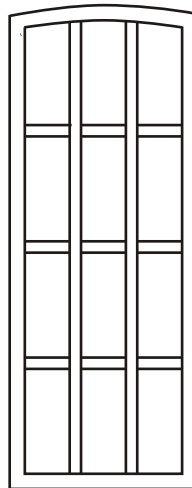
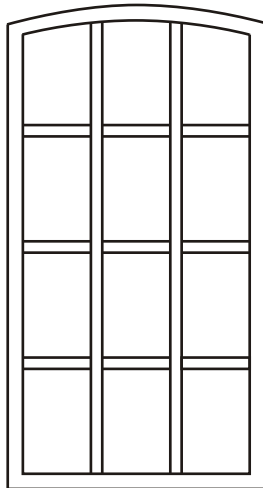

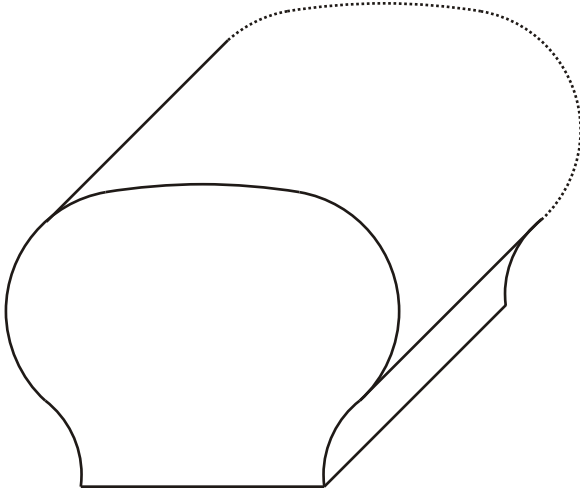

HL65/50

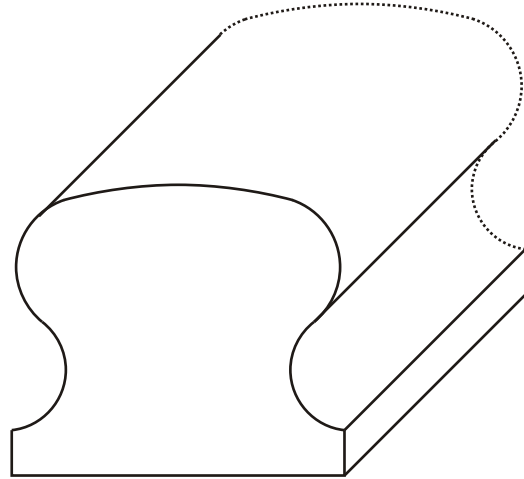

HL55/48

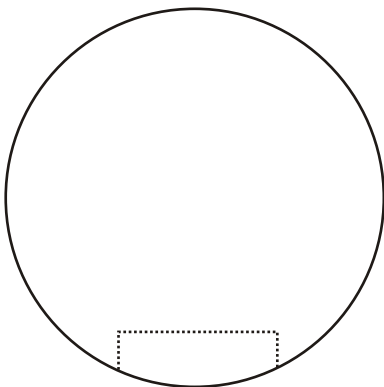

Rundstab 50 mm

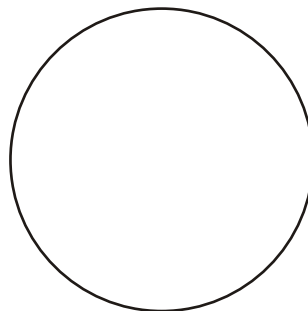

Rundstab 40 mm

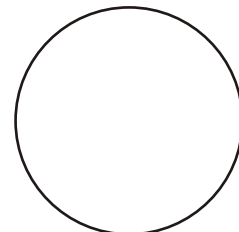

Rundstab 30 mm

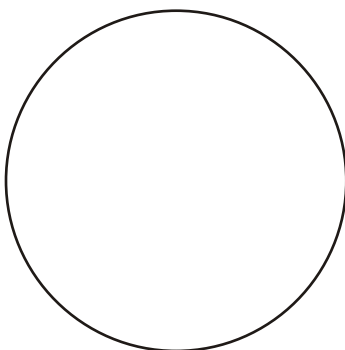

Rundstab 45 mm

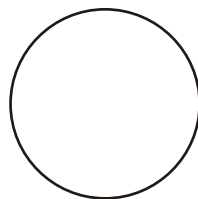

Rundstab 25 mm

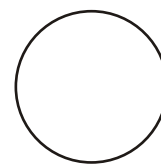

Rundstab 20 mm

Treppenantrittspfosten
Querschnitt 90 x 90 mm
Profilierung auch nach Ihren Angaben

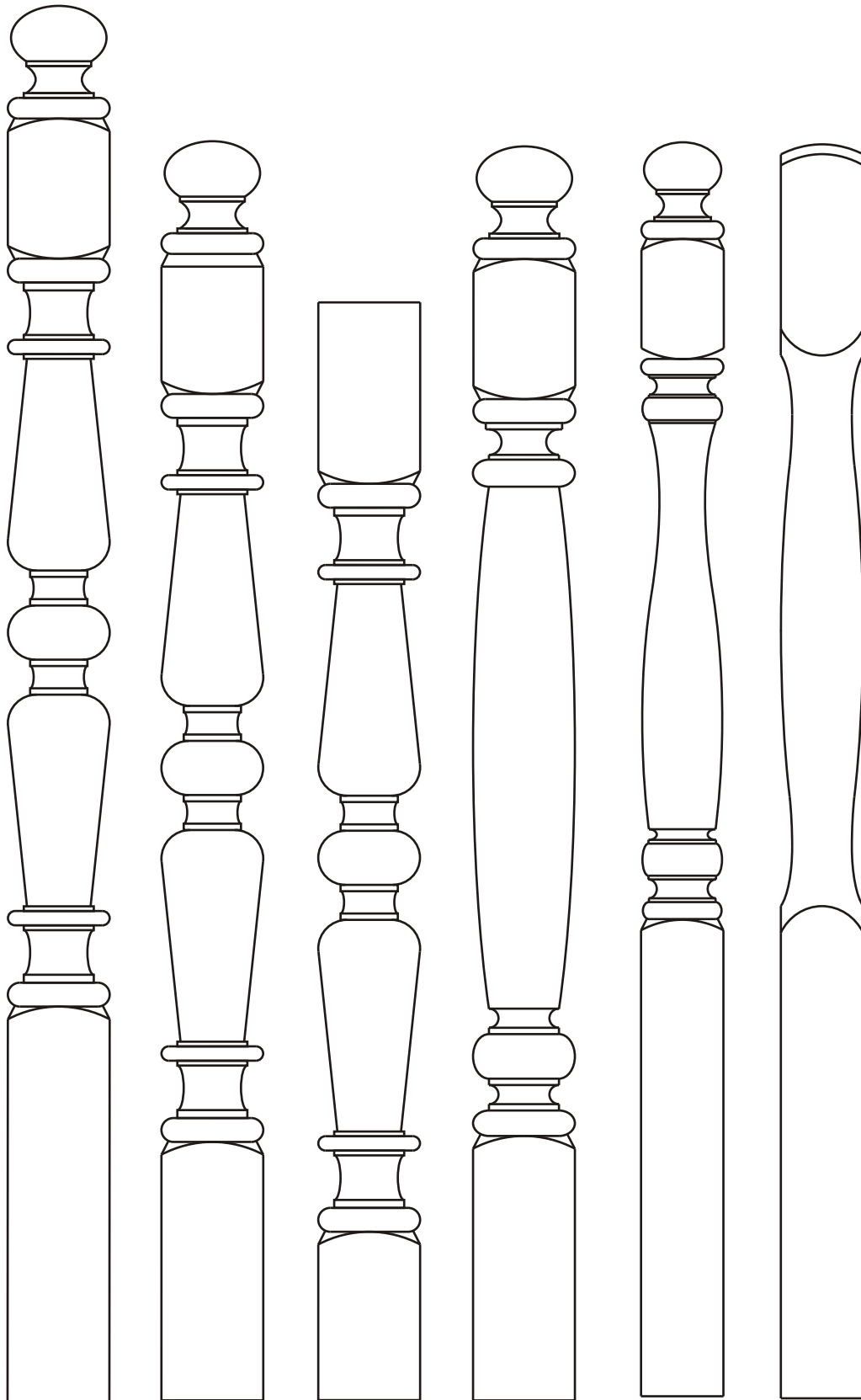

Treppenstäbe
- in verschiedenen Durchmessern
Profilierung auch nach Ihren Angaben

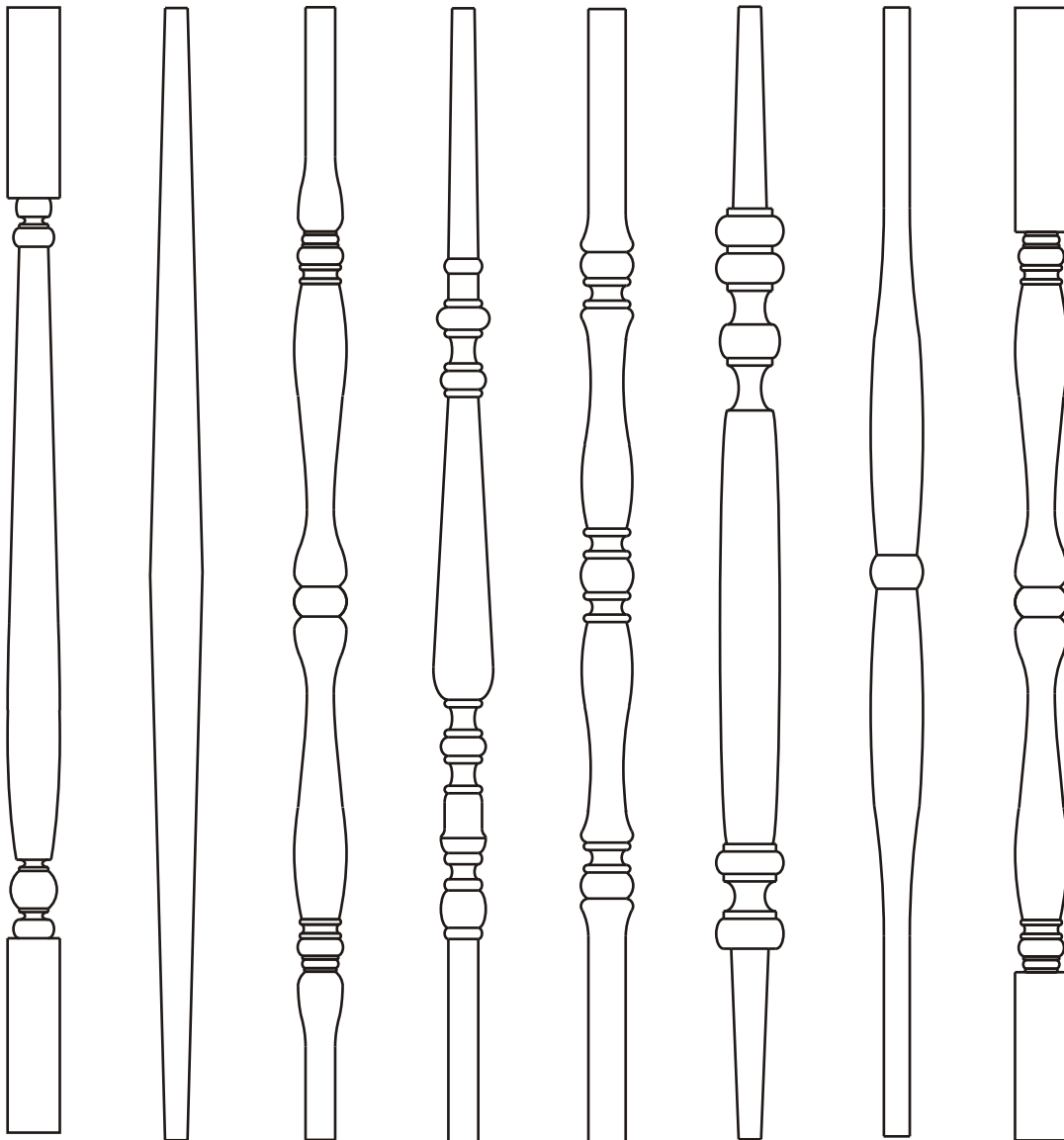

S yx

S 10

S 15

S 18

S 20

S 25

S xx

S xy

KugelfüÙe



| Durchmesser | Höhe | Best.-Nr. |
|-------------|-------|-----------|
| 70 mm | 75 mm | KF 1 |
| 90 mm | 80 mm | KF 4 |
| 110 mm | 80 mm | KF 5 |

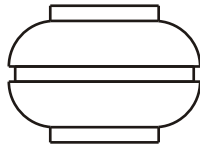

| | | |
|--------|--------|--------|
| 70 mm | 50 mm | KF 70 |
| 100 mm | 70 mm | KF 100 |
| 120 mm | 80 mm | KF 120 |
| 160 mm | 100 mm | KF 160 |

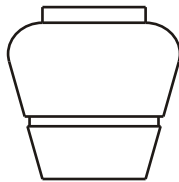

| | | |
|-------|-------|------|
| 60 mm | 60 mm | KF 6 |
| 80 mm | 80 mm | KF 7 |



| | | |
|--------|--------|--------|
| 150 mm | 120 mm | KF 150 |
|--------|--------|--------|

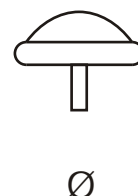
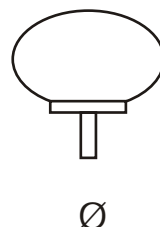
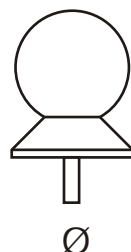
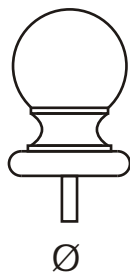

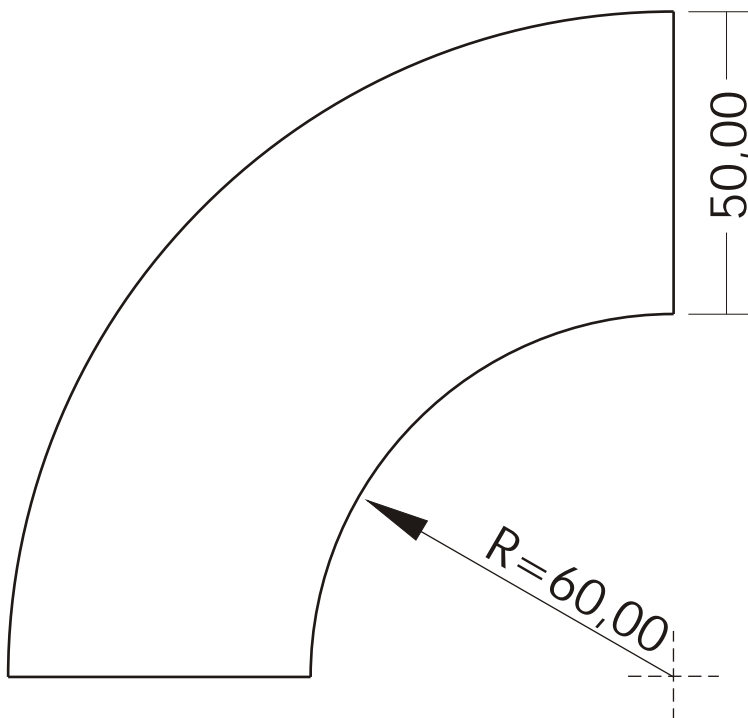
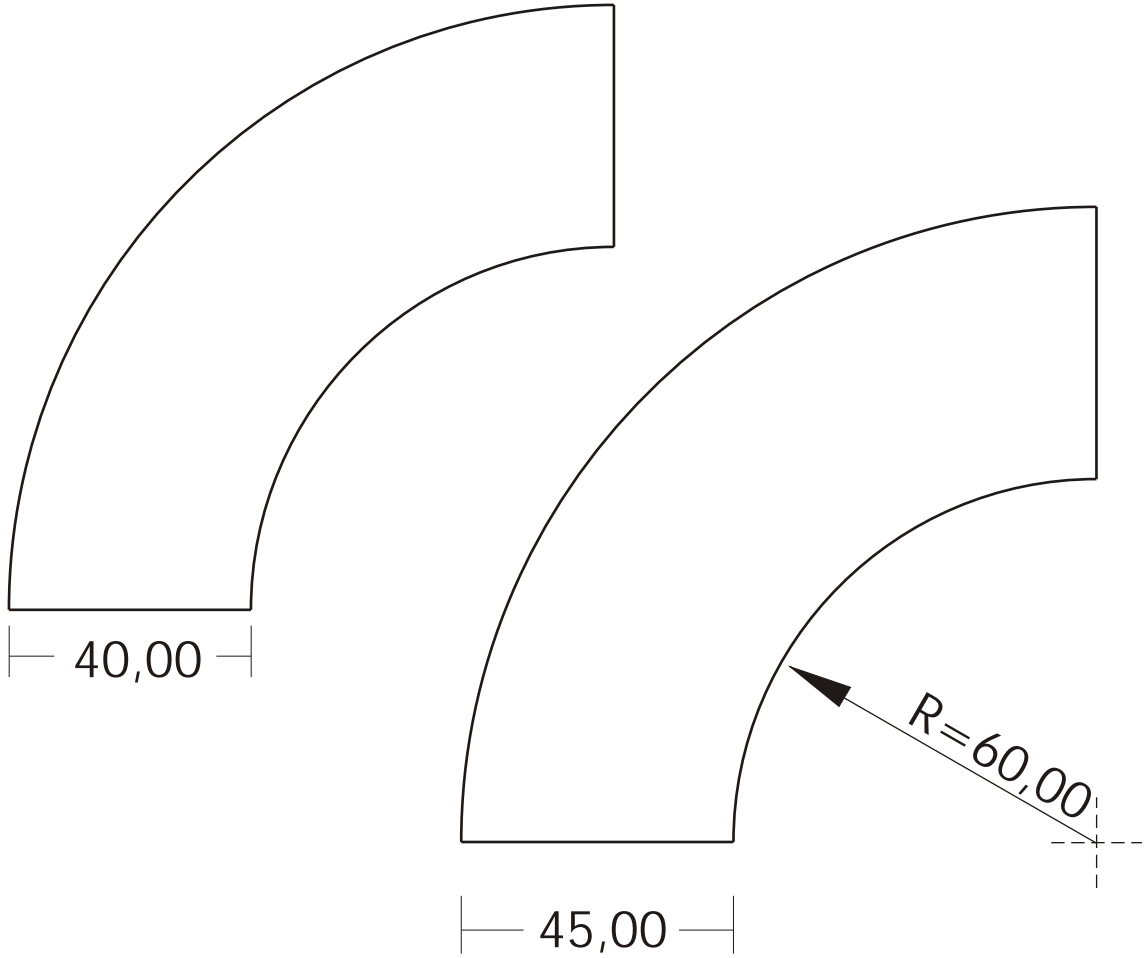

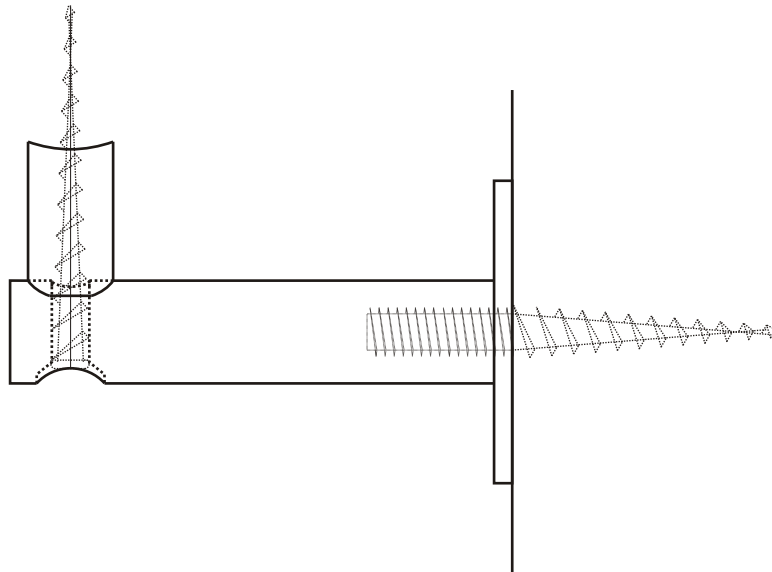
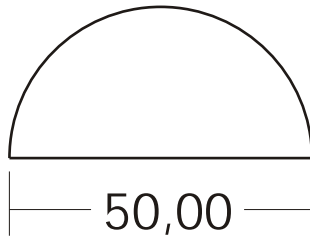
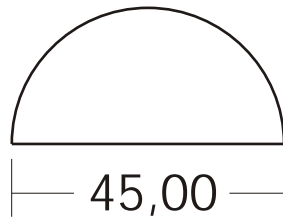
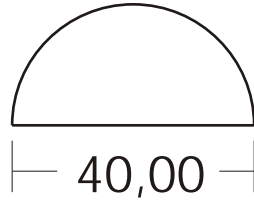

Abdeckkappen

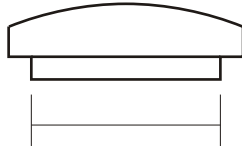

10, 15, 20, 25, 35mm

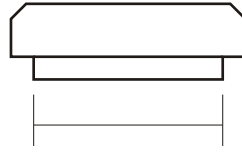

10, 15, 20, 25, 35mm



Rundstäbe

in den Durchmessern

4, 5, 6, 8, 10, 12, 14, 15, 16, 18, 20,
22, 25, 28, 30, 32 mm Buche

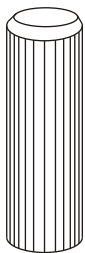

Riffeldübel

in den Durchmessern

6, 8, 10, 12, 14, 16, 20

in den Längen

30, 40, 50, 60, 70, 80, 90, 100

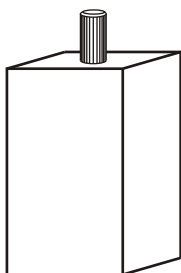

Hinterfuß

80 mm

HF 9

100 mm

HF 10

Außerdem fertigen wir standartmäßig
und nach ihren Angaben:

Anleimer

B

C

D

E

F

G

H

I

J

K

L

M

N

O

P

Q

R

S

T

U

V

W

X

Y

Zedernvollholzleisten

Gerne stehen wir Ihnen zur Seite
bei weiteren Wünschen, Ideen
und Anfragen die an dieser
Stelle noch nicht aufgeführt sind.